



secret jardin

ASSEMBLY INSTRUCTIONS



DARK PROPAGATOR R4.00

ACCESSORIES	p.2
STRUCTURE ASSEMBLY	p.3
CANVAS & ACCESSORIES ASSEMBLY	p.7
CONFIGURATION	p.8



DUCTING FLANGE Ø16

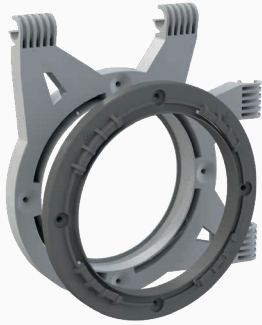

Ducting Flange x2



Cutting Tool x1



Light Baffle x1



Connectors x1
100 - 125 - 150 mm

CABLE FLANGE Ø7



Cable Flange x1



Cutting Tool x1

GENERAL

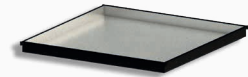

WaterTray x1



CableIT

DP60 x15
DP90 x15
DP120 x30

METAL GRID

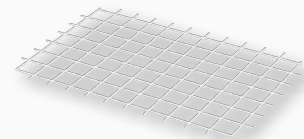

Grid

DP90 Option
DP120 x12



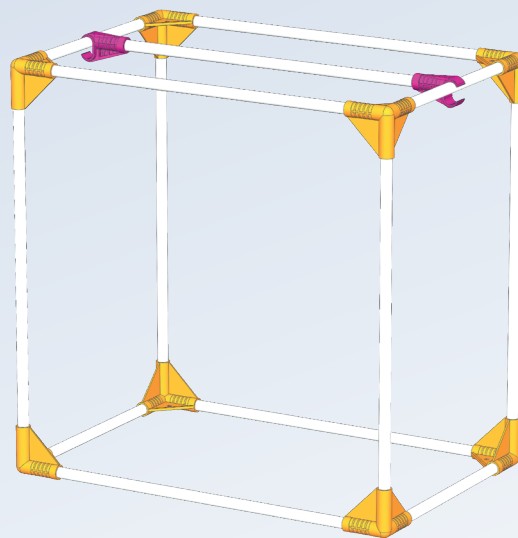
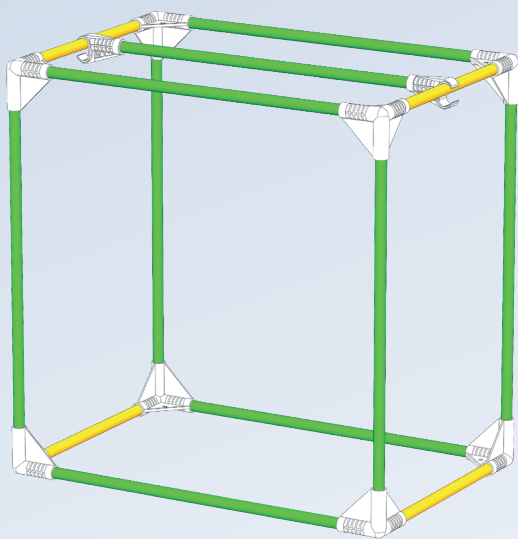

Clips

DP90 Option
DP120 x48

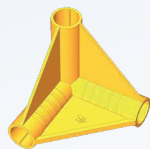

9x T16-60
4 x T16-40



8x C16-Y



2x C16-H

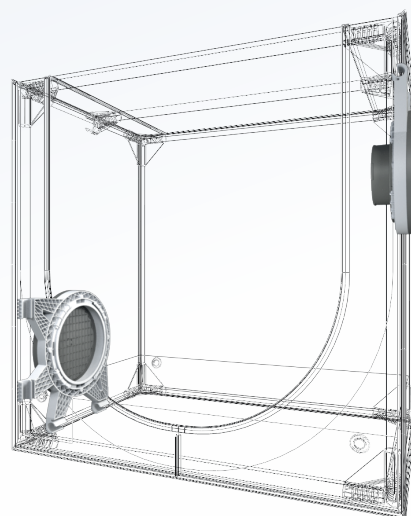

Canvas & accessories
assembly p.7



CONFIGURATION 1 : 1x FLOOR (100CM - 40")

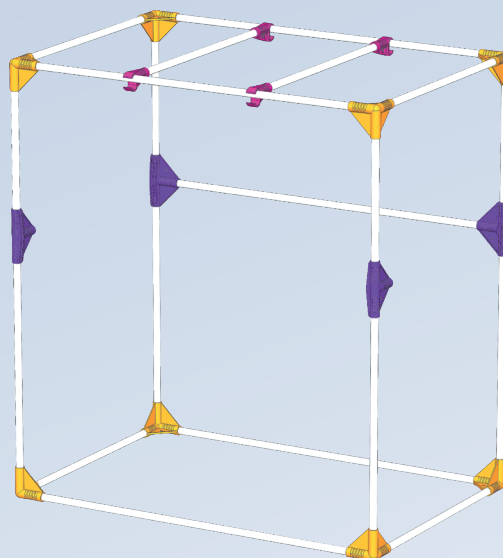
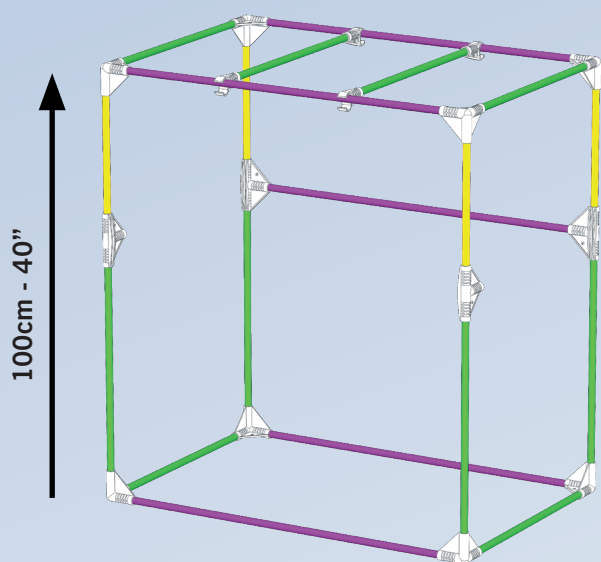

CONFIGURATION 3 : 2x FLOORS (GRIDS SOLD ON OPTION)

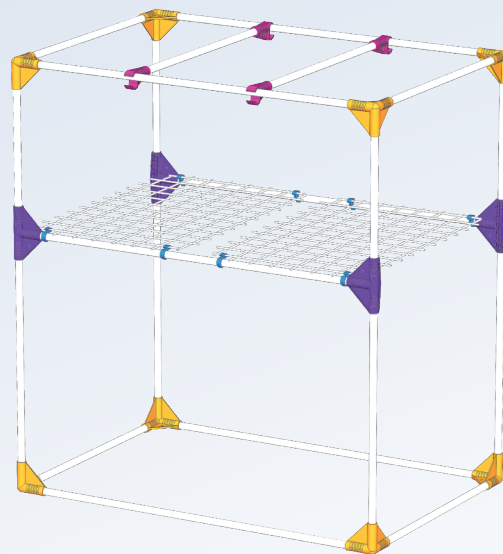
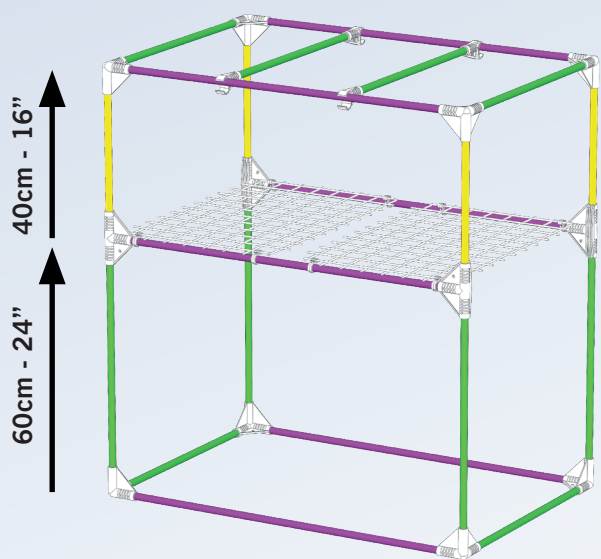

CONFIGURATION 2 : 1X FLOOR (60CM - 24")

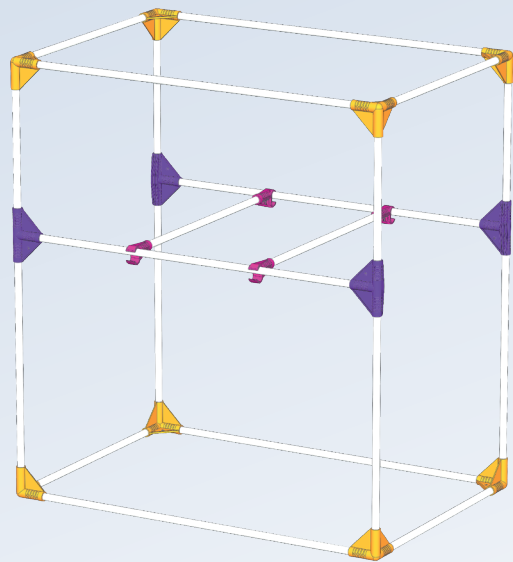
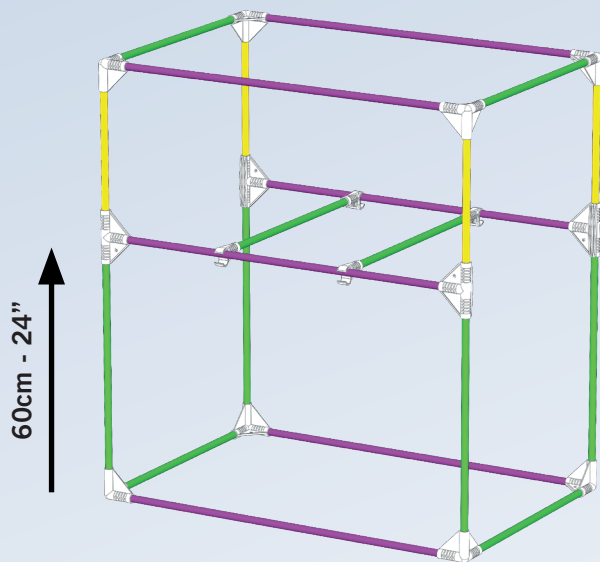

6 x T16-90

2+8 x T16-60

4 x T16-40

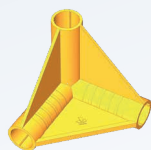

8x C16-Y



4x C16-T



4x C16-H

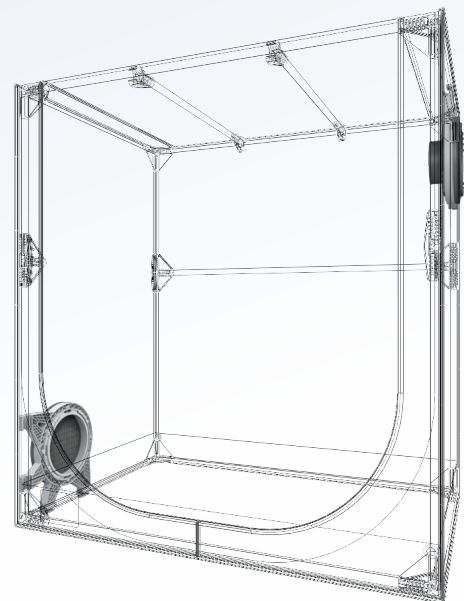

Canvas & accessories
assembly p.7



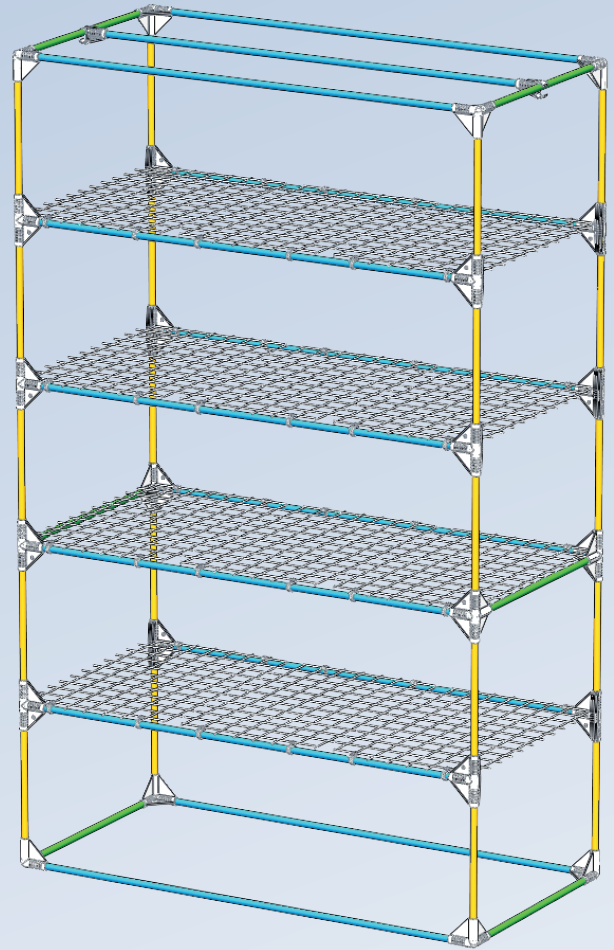
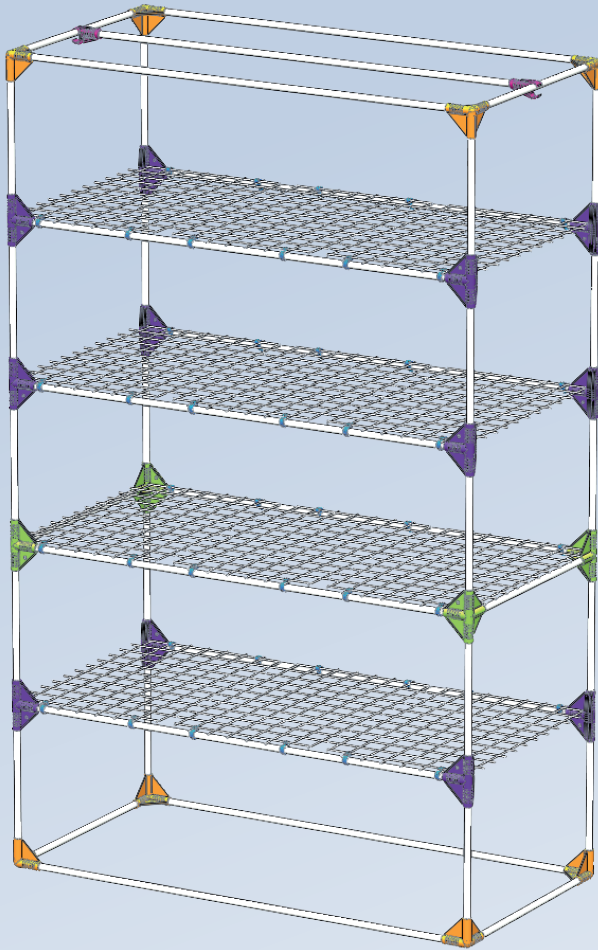

13x T16-120

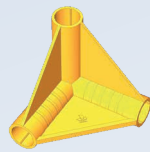

8x C16-Y



12x C16-T

6x T16-60

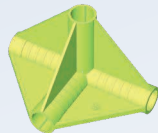

4x C16-K



48x Clips

20 x T16-40



2x C16-H

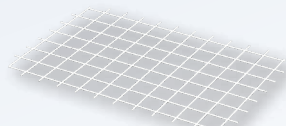

12x Grid6040



**Canvas & accessories
assembly p.7**

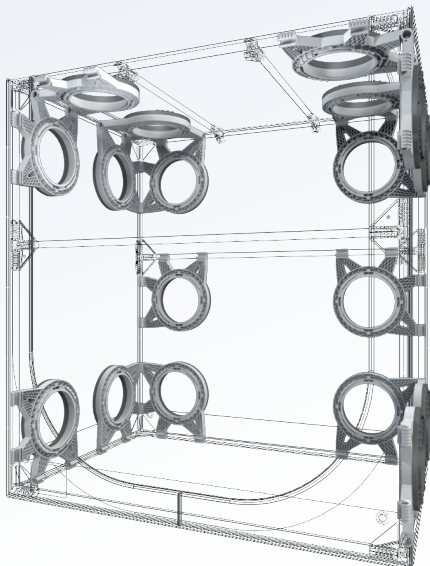
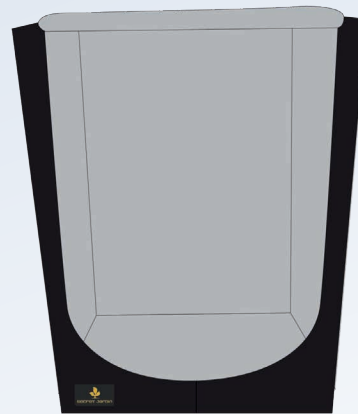
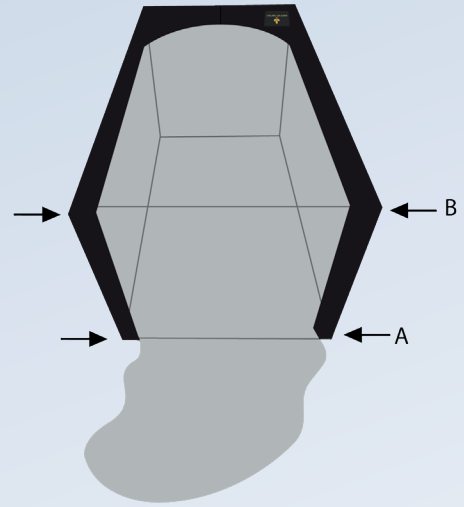
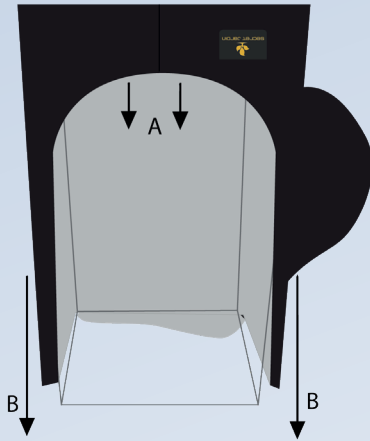

DUCTING & CABLE FLANGES



METRIC

DARK PROPAGATION			WGTT		HANDLING		LIGHTING	VOL	VENTILATION ADVISED			
REF	DESIGNATION	REV	Net kg	#	L cm	Weight Per Pole	Advised	m3	HOT every 1-2 min		COLD every 2-4 min	
									Extraction	Intake	Extraction	Intake
DP60	Dark Propagator 60 x 40 x 60 cm	R4.00	3,3	1	60	10 kg	1 TLED26W	0,1	10 m3/h	-	5 m3/h	-
DP90	Dark Propagator 90 x 60 x 98 cm	R4.00	5,8	2	60	10 kg	2 TLED26W	0,5	30 m3/h	-	15 m3/h	-
DP120	Dark Propagator 120 x 60 x 190 cm	R4.00	19,8	1	120	10 kg	4 TLED42W	1,4	80 m3/h	-	40 m3/h	-

IMPERIAL

DARK PROPAGATION			WGTT		HANDLING		LIGHTING	VOL	VENTILATION ADVISED			
REF	DESIGNATION	REV	Net lb	#	L in	Weight Max/Pole	Advised	cf	HOT every 1-2 min		COLD every 2-4 min	
									Extraction	Intake	Extraction	Intake
DP60	Dark Propagator 2' x 1 1/3' x 2'	R4.00	7,3	1	24	20 lb	1 TLED26W	5	5 cfm	-	3 cfm	-
DP90	Dark Propagator 3' x 2' x 3 1/3'	R4.00	12,8	2	24	20 lb	2 TLED26W	20	20 cfm	-	10 cfm	-
DP120	Dark Propagator 4' x 2' x 6 2/3'	R4.00	43,7	1	47	20 lb	4 TLED42W	49	45 cfm	-	22 cfm	-



info@secretjardin.com



SECRET JARDIN



www.secretjardin.com